

INSTALLATION, USER AND MAINTENANCE MANUAL



Refrigeration monoblock

EUROMON

01.2020

INDEX

1. PRODUCT SPECIFICATIONS	3
1.1. DESCRIPTION.....	3
1.2. DESIGNATION.....	4
1.3. OPERATING LIMITS.....	4
1.4. TECHNICAL CHARACTERISTICS AND DIMENSIONS	4
1.5. EQUIPMENT DESIGN	5
2. UNIT PREPARATION FOR USE.....	5
2.1. TRANSPORT	5
2.2. IMPORTANT SAFETY WARNINGS.....	6
2.3. INDICATIONS.....	7
2.4. INSTALLING THE UNIT	9
2.5. COMPULSORY SPACE TO BE LEFT AROUND THE UNIT	9
2.6. ASSEMBLY.....	9
2.7. PROTECTIVE DEVICES AND SAFETY MEASURES	11
2.8. DISPOSING OF PACKAGING	11
2.9. CONTROLS, ADJUSTMENTS AND CHECKS TO BE MADE.....	11
3. OPERATING INSTRUCTIONS.....	11
3.1. CONNECTING THE UNIT TO EXTERNAL POWER SOURCES.....	11
3.2. ELECTRICAL POWER CONNECTION.....	11
3.3. ADJUSTMENT AND CONTROL	12
3.4. COLD ROOM LIGHT.....	13
3.5. CONTROL DEVICE	13
3.6. CONTROL FUNCTIONS.....	14
3.7. INDICATOR LIGHTS.....	15
3.8. ALARM SIGNALS	15
3.9. RESETTING THE ALARMS.....	15
3.10. PAL/CA ALARM.....	16
3.11. P1, P2, P3, P4 ALARM	18
3.12. dA ALARM.....	19
3.13. COMPRESSOR ALARM DOES NOT START.....	19
3.14. PARAMETER LIST	20
3.15. EXTERNAL COMMUNICATION	20
3.16. STARTING UP THE UNIT.....	21
3.17. DIAGRAM OF THE UNIT ELECTRICAL SYSTEM	21
4. MAINTENANCE AND CLEANING.....	21
4.1. MAINTENANCE AND REPAIR OF THE UNIT	21
4.2. ORDINARY MAINTENANCE	21
4.3. PERIODIC AND PREVENTIVE MAINTENANCE.....	22
4.4. SERVICING TO BE CARRIED OUT BY QUALIFIED STAFF	22
4.5. TECHNICAL PROBLEMS	22
4.6. FAILURE ANALYSIS.....	24
4.7. HOW TO ORDER SPARE PARTS.....	25
4.8. SCRAPPING THE UNIT.....	25

1. PRODUCT SPECIFICATIONS

1.1. DESCRIPTION

EUROMON commercial equipments are compact wall compression cooling units, air-cooled, for cold storage rooms which have a small volume and for use in medium and low temperature, governed by an intelligent control. The power supply is single phase or three phase depending on the equipment. They consist of:

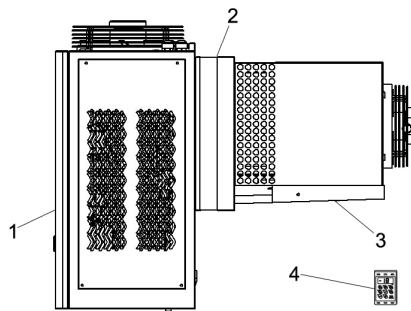

- 1 condenser unit installed externally to the cold room an insulating
- 2 panel for fitting to the wall of the cold room
- 3 an evaporator installed inside the cold room
- 4 an electrical control and command panel, located in the condenser unit

The EUROMON is a totally compact cooling unit, easy to install and with easy access to the inside of the unit, making maintenance simple, quick and safe.

- It is constructed in treated sheet metal with a prepainted finish
- Its batteries are built with copper tube and aluminium fins
- The evaporator is forced draught type, with air condensation
- The compressors are hermetic type and they can be supplied to operate with different refrigerants (R-404A, R-452A, R-449A, R-448A)

The EUROMON are equipped with:

- Refrigerant charge.
- Hermetic compressor.
- Thermostatic expansion valve
- High and low pressure switches.
- Automatic defrosting by hot gas.
- System for partial evaporation of defrosts water.
- Cables for supply, door micro switch and cold room light (2,5 m. each)
- Watertight cold room light.
- Voltage protector
- Condensation control by pressure switch.
- Integrated multifunctional electronic control
- Ceramic Filter Drier
- Probe alert "dirty condenser"
- Insulation panel included.
- Install under roof

This manual is an integral part of the equipment and should ALWAYS accompany it. It must be protected, at all times, from any possible deterioration during the whole life of the equipment. It contains the necessary instructions for maintenance technicians and should ALWAYS be easily accessible to them.

The manufacturer reserves the right to make modifications and / or improve this document without prior notice.

WARNING
Contains fluorinated greenhouse gases.

1.2. DESIGNATION

EMB 2 009 M 1 Z

EMB	Indicates the unit family
2	Indicates a group within the family
009	Indicates the compressor
M	Indicates the work range: M = refrigeration (medium temperature) L = freezing
1	Indicates the voltage 1 = 230/1/50 2 = 220/1/60 3 = 230/3/50 4 = 220/3/60 5 = 400/3/50 6 = 380/3/60 7 = 460/3/60
Z	Z = R-404A X = R-449A T = R-452A

1.3. OPERATING LIMITS

The EUROMON units are designed for correct continuous functioning between the temperature limits shown in the following table.

	Max.	Min.
Refrigeration	+10°C	-5°C *
Freezing	-15°C	-25°C

* The cold room needs to be designed as if it was a freezing chamber.

Sound pressure level dB (A) <70 db (A) at 10 m of the unit measured in open field

1.4. TECHNICAL CHARACTERISTICS AND DIMENSIONS

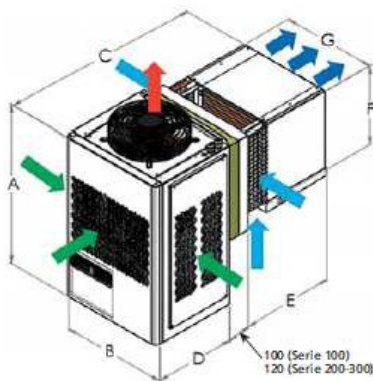

Unit with axial fan (EMB)

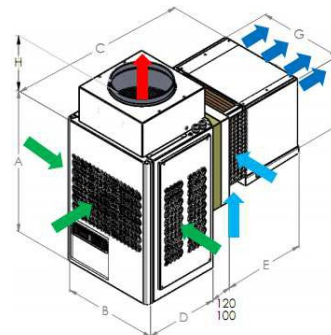

Unit with centrifugal fan (EMC)

series	EQUIPO – UNIT - UNITÉ								CORTE PANEL – PANNEL CUT – COUPÉ PANNEAU	
									TAMPON – PLUG IN – SUR PANNEAU	
	A	B	C	D	E	F	G	H	HORIZONTAL	VERTICAL
100	730	445	910	360	455	345	390	190	415	400
200	800	685	1000	410	470	345	620	250	640	410
300	800	735	1050	410	515	410	670	250	690	475

1.5. EQUIPMENT DESIGN

The units are agree with the those directives:

- Machine security..... 2006/42/CE
- Electromagnetic compatibility 2014/30/UE
- Low voltage 2014/35/UE
- Pressure units..... 2014/68/UE
 - Category art.. 4.3
 - PS HP/LP 30/17 bar

Attached with each unit corresponding EC Declaration of Conformity

2. UNIT PREPARATION FOR USE

2.1. TRANSPORT

The cooling unit must be handled with care to prevent any damage being caused during transport, in accordance with the following instructions:

- Do not start up the unit until 6 hours have elapsed after transportation
- The unit must be transported and handled in vertical position, protecting it against water and knocks
- Never stack the units during transport without being well insured.
- Never stack the units in the warehouse above the recommended safety limits.
- Use suitable machinery to move the unit
- Do not remove the pallet or packaging until the machine is in its final location



The unit must be moved using suitable means of transport and hoisting, and this must be done by authorised staff. **TO SEPARATE THE UNIT FROM THE PALLET, REMOVE THE FIXING BOLTS.**

WARNINGS

Ensure no people are transiting through the area in which the machine is being transported and handled. **RISK OF KNOCKS, TRAPPING AND CRUSHING.**

Whether the unit is packaged or not, it must always be transported, hoisted and handled in its original position, never laid down, for safety reasons and to prevent it from falling. **RISK OF BREAKAGE OF THE UNIT, DAMAGE TO THE BUILDING AND PERSONAL ACCIDENT.**



2.2. IMPORTANT SAFETY WARNINGS

Below are some safety tips to be followed during the installation and use of the unit.

- The unit must be installed in accordance with the diagrams and recommendations provided by the Manufacturer.
- Damage due to improper connections is not covered.
- A neutral conductor may not be used as a protection conductor, even if it has an earth connection.
- The electrical installation on the premises where the unit is installed must be in compliance with the applicable regulations concerning electrical installations and electromagnetic protection.
- For equipments with centrifugal fan, before starting the machine you must connect a pipe of at least one meter to the fan. This connection must be made so that there are no openings.
- Maintenance of the unit must be carried out by qualified, authorised staff, in compliance with all the stipulations set out in standard EN378 and the regulations applicable to this effect in each particular country.
- Guards should only be removed for maintenance or repair
- It is necessary to consign the equipment before removing the fan guard or remove its guard to perform maintenance or repair

WARNING

To prevent danger of cuts to hands, use protective gloves.

If the user wishes to use the unit for any purpose it is not designed for, particularly during its use, or for any servicing they wish to have done, they must ask the Manufacturer to inform them of any contraindications or hazards that could arise from improper use of the unit.

- The unit must be used in accordance with the instructions for use and for the purposes for which it was designed by the Manufacturer. Any improper use of the equipment constitutes an anomalous condition and may cause damage to the unit itself and be a serious health hazard for other people.

CAUTION

This unit is not designed to work in an explosive atmosphere. Its use in a potentially explosive environment is therefore strictly forbidden.

CAUTION

This unit is not designed to work in a saline atmosphere. In this case the condenser and/or evaporator will need to be protected using the most suitable systems.

WARNING

Cooling fluid must not be discharged into the atmosphere. It must be recycled by authorised specialist technicians with suitable equipment

In case of servicing involving the refrigeration circuit, the system must be drained and set at atmospheric pressure

- Refrigerant refill is to be carried out in accordance with the indications on the reference plate concerning the type and amount of refrigerant.
- No refrigerant of a type other than that indicated is to be used.
- No modifications or alterations of the components' cooling and electrical circuits are to be made, or any soldering in the compressor or cabling modifications.
- The end user must protect the installation against fire hazard.

2.3. INDICATIONS

The manufacturer has applied the use of warning labels and the guidance given in the following summary table.

Producto/Product/Produit	1	
Modelo/Model/Modèle	2	
NºSerie/Serial No./NºSérie	3	
Año Fab./Man. Year/Année Fab.	4	
Refrigerante/Refrigerant/Réfrigérant	5	
Carga /Load/Charge: (kg / Ton CO ₂)	6	
Añadido/Added/Ajoutée:	6	
Total /Total/Total :	6	
Peso/Weight/Poids (kg)	V / Ph. / Hz	I _{max.} (A)
7	8	9
According PED 2014/68/UE	PS H/L (bar)	TS (°C)
10	11	12

- 1) Product
- 2) Unit model
- 3) Unit serial number
- 4) Year of manufacture
- 5) Type of refrigerant
- 6) Amount of refrigerant
- 7) Weight of the unit
- 8) Tension
- 9) Maximum current of the unit
- 10) Category of the equipment
- 11) Design pressure
- 12) Design temperature

“Contiene gases fluorados de efecto invernadero”
 “Contains fluorinated greenhouse gases”
 “Contien des gaz à effet de serre fluorés”
 “Es enthält erfasste fluorierte Treibhausgase”
 “Berotegi-efektuko gas fluordunak, dauzka”

R 404 A
 PCA / GWP 100: 3922

**DESAGÜE
 CONDENSACIÓN**

Condensed drain line

Évacuation des condensats

Kondentsazloko hustubidea

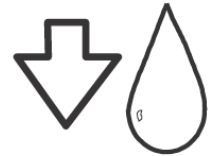

! CUIDADO ; Peligro de electrocución.
 Antes de manipular el equipo quite la corriente.

! CAUTION! Risk of electric shock.
 Disconnect power before servicing unit.

! ATENTION; Danger d´electocution
 Avant de manipuler coupez le courant.

! KONTUZ; Erabili aurretik argi
 Indarra deskonektatu



**! CUIDADO ;
 Partes calientes/frías**

“CAUTION!
 Warm / cold parts

! ATENTION;
 Partles chaudes/froides

! KONTUZ;
 Alde beroak/hotzak



██████████ L 1/ R
 ██████████ L 2/ S
 Azul - Blue - Bleu - Urdina L 3/ T
 ██████████ N
 Amarillo-Verde-Yellow-Green-Jane Vert - Horia-Berdea

Conectar este cable a un interruptor magnetotérmico. Nunca directamente a la línea principal.
 Connection should always be made from a fused isolator. Never connect the cable to the main supply line directly.
 Racorder ce câble à un interrupteur magneto-termique. Jamais directement à la ligne principale.
 Kable hau etengailu magneto-termiko batera konektatu. Inoiz ere ez argi indar sare nagusira.



G

E27

**Cable luz cámara.
 No conectar a la línea de alimentación.**

Coldroom ligh.
 Do not connect to the supply line.

Câble de la lumiere. Ne pas brancher à la ligne d'alimentation

Kamarako argia.
 Ez konektatu elikatze sareraz

Salida / Output / Sortie



230 V / 60 w



██████████ L
 Azul - Blue - Bleu - Urdina N
 Amarillo-Verde-Yellow-Green-Jane Vert - Horia-Berdea

Conectar este cable a un interruptor magnetotérmico. Nunca directamente a la línea principal.

Connection should always be made from a fused isolator. Never connect the cable to the main supply line directly.
 Racorder ce câble à un interrupteur magneto-termique. Jamais directement à la ligne principale.
 Kable hau etengailu magneto-termiko batera konektatu. Inoiz ere ez argi indar sare nagusira.



G

Cable micro-puerta

Microswitch door cable

Câble micro-porte

Ateko mikroaren kablea

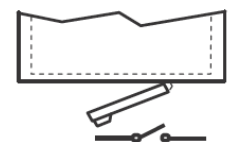
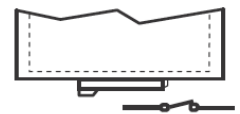

2.4. INSTALLING THE UNIT

To guarantee correct functioning of the EUROMON, for optimising its electrical consumption per Kg of product stored and to prevent breakdown, it is vitally important that it is placed in a suitable location and properly used.

Condenser

- Ensure air is circulating through the condenser
- Locate it away from sources of heat
- Ensure the air entering is as fresh as possible and that the air exiting is not mixed with the air entering
- Ensure there is sufficient space around the air inlets and outlets
- Keep the condenser clean
- Provide an access point for maintenance and servicing
- Provide a drain tube for any condensation that may form.
- The electrical supplies must be protected by suitable magnetothermic switches and differential switches.
- Provide a drain tube for any condensation that may form and connect it to the drain, located in the lower part of the unit

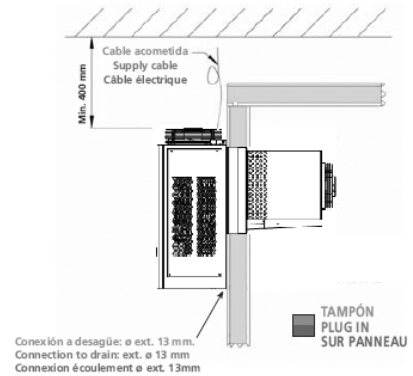

Evaporator

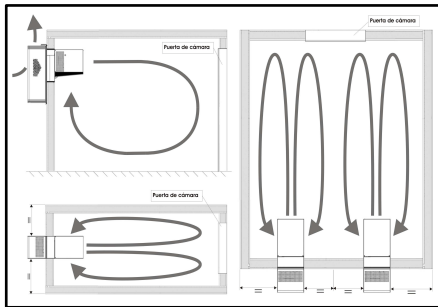

- Make sure the cold room door is only kept open when strictly necessary
- Provide the door with a protective seal to prevent warm, damp air from entering from outside (particularly for low temperature cold rooms and on premises with a high ambient humidity).
- Do not place very hot food inside the cold room (it is not a chiller)
- Do not place food for freezing in the cold room (it is not a cooling tunnel)
- Leave room for the air to circulate. Observe the load limits in the enclosed diagram.
- Seal any points through which air could enter from outside.

NOTE: EUROMON units have a system for partial evaporation of the defrost water. This water must run off to a drain if it does not totally evaporate.

2.5. COMPULSORY SPACE TO BE LEFT AROUND THE UNIT

The unit's location must allow access for the relevant technical and maintenance service to be carried out, in compliance with all the safety requirements applicable in the country. It must be installed in places where good ventilation and air circulation is guaranteed. It must have a minimum clearance of 0.4m.

The minimum recommended insulation thicknesses for the camera are:

- Refrigeration: 60mm
- Freezing: 100mm

2.6. ASSEMBLY

- A) Make a hole in the wall of the camera, depending on the model, of adequate dimensions HxL, as indicated in the table below.
- B) Raise the unit, using the most suitable means, placing it against the hole in the wall. Insert it from the outside, leaving out the condensing part.
- C) Fix the unit to the wall with screws.
- D) Seal the panel cutting perimeter. To prevent leaks of hot air from the outside.

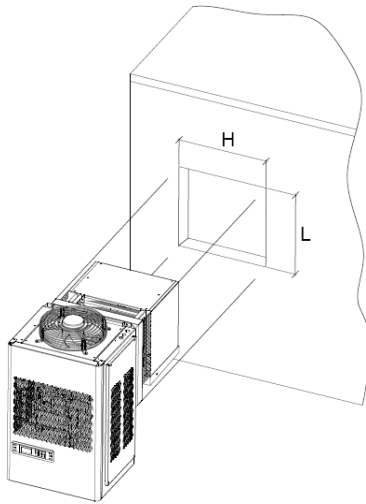

PANNEL CUT / CORTE PANEL / COUPÉ PANNEAU		
SERIE	H*	L*
100	415	400
200	640	410
300	690	475

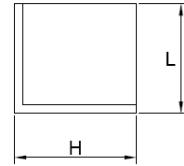

* DIMENSIONS IN mm.
DIMENSIONES EN mm.
DIMENSIONS EN mm.

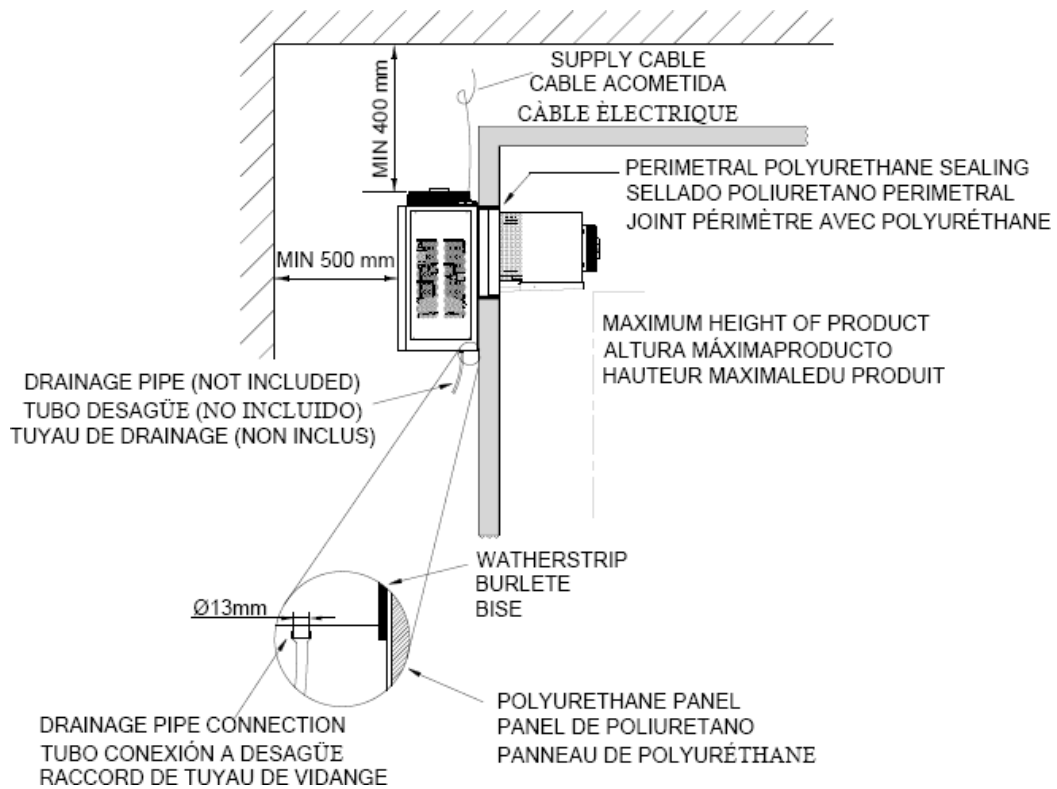

For equipments with centrifugal fan in the condenser, you must install a duct with the following measures for each unit.

In any case the length of this duct must not exceed 10m.

series	Diámetro del conducto
	Duct diameter
	Diamètre conduit
	mm.
100	250
200	315
300	

2.7. PROTECTIVE DEVICES AND SAFETY MEASURES

The manufacturer has provided the following safety protections:

1. The metal casing is bolted to the structure.
2. The fans are bolted to the metal structure.
3. The fan access is covered by a grille bolted in place.
4. The motor compressors have thermal protection.
5. The units have a high pressure switch with manual reset for protection against high pressures.

IMPORTANT

The protective devices have been fitted by the manufacturer for user safety during work.

2.8. DISPOSING OF PACKAGING

Wooden, cardboard, plastic and polystyrene packaging must be disposed of in accordance with the laws applicable in the country in which the unit is used.

2.9. CONTROLS, ADJUSTMENTS AND CHECKS TO BE MADE

Before starting up the unit, check that:

- the fixing bolts are properly tightened,
- the electrical connections have been properly made.
- the electrical connections are properly tightened

In case of opening the unit, check that:

- no tools have been left inside the unit
- the assembly has been made correctly,
- there are no gas leaks,
- the front cover has been correctly fitted.

3. OPERATING INSTRUCTIONS

3.1. CONNECTING THE UNIT TO EXTERNAL POWER SOURCES

CAUTION

Before making the electrical connection, check that the mains voltage and frequency are as indicated on the unit label and that the current remains at a tolerance of +/- 10% with respect to the nominal value. IF THE CURRENT DOES NOT REMAIN WITHIN THIS TOLERANCE, THE USER MUST PROVIDE VOLTAGE STABILISERS.

3.2. ELECTRICAL POWER CONNECTION

You must perform a preliminary inspection of the components of the electrical panel, and then proceed to the electrical connection.

CAUTION

The line connection must be made with a suitable protection device (magnetothermic switch or magnetothermic differential switch) selected by the installer or by qualified, authorised staff on the basis of the line type and consumption indicated on the unit label.

If there is more than one unit in a cold room, each unit must have its own protection device.

CAUTION

The machine must be connected to the grounding system prior to commissioning. The system shall comply with the requirements of national regulations.

SUPPLY CABLE

a) 230V/1/50-60Hz	3 wires	Blue=Neutral Yellow/Green=earth Brown, Black or Grey=phase
b) 400V/3/50-60Hz	5 wires	Blue=Neutral Yellow/Green=earth Brown=phase Black=phase Grey=phase

The unit is equipped with:

- a door micro switch cable (door micro switch not supplied).
- a cold room light cable
- a porthole with an incandescent 230V/60W light bulb.

CAUTION



Do not connect the door micro switch cables and cold room light cable to the supply line.

3.3. ADJUSTMENT AND CONTROL

The unit is governed by an electronic circuit board and digital control device.

The unit functioning is adjusted by a cold room thermostatic temperature control according to the temperature setting made by the user. So, when the cold room temperature is higher than the temperature setting plus a differential value, the cooling cycle starts up, and it stops when the cold room temperature is the same as the temperature setting.

In this operating mode the digital display of the control shows the cold room temperature.

The temperature setting can be viewed by pressing the button , and changed by pressing the  and  buttons.

To protect the compressor from successive start-up and stopping, the adjustment system includes an anti-short cycle timer.

The unit automatically goes into defrost mode after a cooling cycle functioning time of 4 hours. The unit is supplied with the defrost mode controlled by the internal battery temperature. In this mode, the defrosting process ends when the internal battery reaches a temperature of 10°C, or after 25 minutes have elapsed.

After defrosting, the unit remains off for the drip time of 3 min so that all the defrost water can run off.

With the configuration the unit is supplied with, the fans remain off during defrosting.

3.4. COLD ROOM LIGHT

The cold room light is switched off and on directly from the unit control using the button  , providing the porthole is connected to the cold room light cable. With the optional Winter Kit, the operating of the camera light on the control board is cancelled.

3.5. CONTROL DEVICE

This consists of a 3-digit digital display, a keypad with 6 buttons and lights showing the operating modes, failures and alarms.

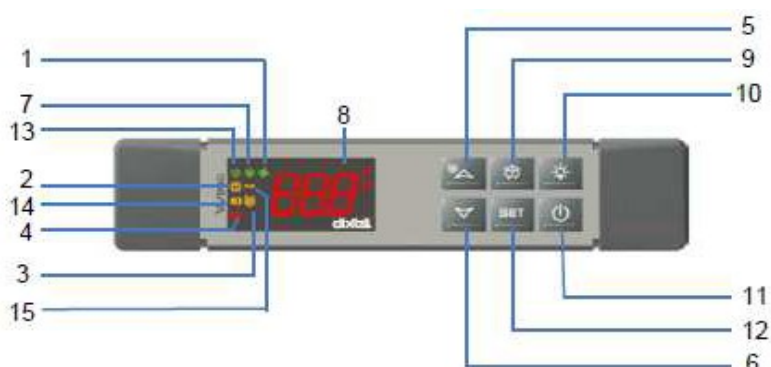

1. Fan warning light
2. Warning light, defrost
3. Warning light, cooling mode
4. Alarm warning light
5. Key maximum temperature
6. Minimum temperature key.
7. Compressor warning Light
8. Digital display
9. Defrost button
10. Camera light button
11. On / Off button
12. Key. Set point and parameter validation
13. Warning lamp Cold room light activated
14. Warning lamp energy saving activated
15. Warning lamp auxiliary relay activated



For viewing and changing the temperature setting. In programming mode, it enables a parameter to be selected and a value to be confirmed. If it is pressed and held down for 3 seconds, when the max. and min. temperatures set are shown they will be erased.



For viewing the maximum temperature set. In programming mode it enables the parameter list to be browsed or the value displayed to be increased.



For viewing the minimum temperature set. In programming mode it enables the parameter list to be browsed or the value displayed to be reduced.



If this button is pressed and held down for 3 seconds, the defrost cycle begins.







For switching the cold room light on or off.









For switching the unit on or off.







3.6. CONTROL FUNCTIONS

- To switch the unit on or off.-
 2. press the  button. “**OFF**” will appear for 5 s.
- To view the maximum temperature set.-
 1. press the  button.
 2. the value will appear on the screen together with the message “**Hi**”.
 3. press the  button and hold it down for 5 seconds to exit.
- To view the minimum temperature set.-
 1. press the  button.
 2. the value will appear on the display together with the message “**Lo**”.
 3. press the  button and hold it down for 5 seconds to exit.
- To erase the maximum and minimum temperatures set.-
 1. while the minimum or maximum temperature is being displayed,
 2. press the button and hold it down until the message “**rST**” appears.

CAUTION

After installing and starting up the unit, do not forget to set the maximum and minimum temperatures.

- To view and change the setting.-
 1. press the **set** button briefly to view the setting
 2. The corresponding indicator light will start to flash.
 3. press the  or  buttons to change the value.
 4. to complete the process, press set or wait for 10 seconds.
- To start a manual defrost cycle.-
 1. press the  button and hold it down for 2 seconds.
- To access the **Pr1** list of user parameters.-
 1. press the **set** and  buttons and hold them down for a few seconds,
 2. the fan and compressor indicator lights will begin to flash,
 3. the first parameter on the list will appear on the display.
- To change a parameter.-
 1. enter the parameter list,
 2. select the desired parameter using the  or  buttons, and press **set** to view its value.

3. press the  or  buttons to change the value.
 4. press set to record the new value and go on to the next parameter.
 5. to exit, press set and the  button or wait for 15 seconds.
- To block the keypad.-
 1. press the  and  buttons and hold them down for 3s.
 2. the message “POF” will appear on the display. Now only the setting and the maximum and minimum temperatures set can be consulted and the cold room light switched on and off.
 3. to unblock the keypad, press the  and  buttons and hold them down for 3s.

3.7. INDICATOR LIGHTS

Indicator	State	Meaning
Compressor indicator light	On	The compressor is functioning.
	Flashing	Anti-short cycle safety device activated. Voltage relay activated High or low pressure switches open. Programming (flashing together with the fan indicator light).
Fan indicator light	On	The fan is functioning.
	Flashing	Programming (flashing together with the compressor indicator light).
Defrost indicator light	On	Functioning in defrost mode.
	Flashing	Defrost complete, drip time
Alarm indicator light	On	An alarm is happening
Energy saving indicator light	On	Energy saving mode activated
Camera light indicator light	On	Camera light is on
AUX indicator light	On	Auxiliar relay is on

3.8. ALARM SIGNALS

Message	Cause	Unit action
P1	Thermostatic sensor failure	Alarm signal. Functioning in safe mode “Con” and “COF”
P2	Evaporator sensor failure	Alarm signal.
P3	Auxiliary sensor failure	Alarm signal.
HA	Maximum temperature alarm	Alarm signal.
LA	Minimum temperature alarm	Alarm signal.
EE	Data or memory failure	Alarm signal.
dA	Door switch alarm	Alarm signal.
CA	Pressure switch alarm. Supply protector relay alarm.	Alarm signal. The unit stops.

3.9. RESETTING THE ALARMS

The alarm signals are silenced by pressing any button or when the cause of the alarm is rectified (according to the option entered for parameter “tBA”, the alarm relay can remain active after the alarm has been silenced).

The sensor failure alarms “P1”, “P2” and “P3” switch off 10 seconds after the failure has been rectified.

The cold chamber temperature alarms “HA” and “LA” switch off when the normal values are reached again or when defrosting begins.

The door alarm “dA” switches off when the door is closed.

The alarm “CA” switches off when the unit is turned off.

3.10. PAL/CA ALARM

Indicative of activation of digital input 13-14, means that it has been activated 2 times in 20 minutes. (Parameters Nps = 2 did = 20).

Possible causes:

1- Analyze if the malfunction contact of the network protector 11-14 is open. If this is the case, observe the status of the protective PR voltage led, if the LED is solid orange, protective ok. See the rest of the states in "Network protection states" on page 18. In case of error, analyze as cause by measuring input voltage to voltage protector A1 - A2 (single phase 230v), L1 - L2 - L3 (three phase 400v).

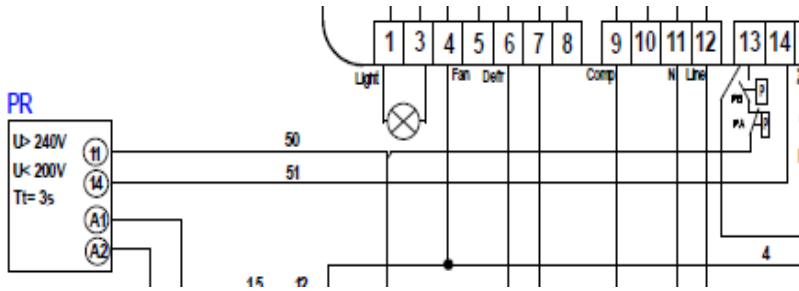

2- Analyze electrically low pressure switch (PB), high pressure switch (PA).

In case PB is open, indicative of stop due to low pressure, causes:

- Pressure switch error or electrical connection pressure switch.
- Coolant leak
- Compressor has started after activation due to cold demand and the liquid solenoid valve has been closed. Analyze state coil solenoid, connection connector coil and terminals (7-0)

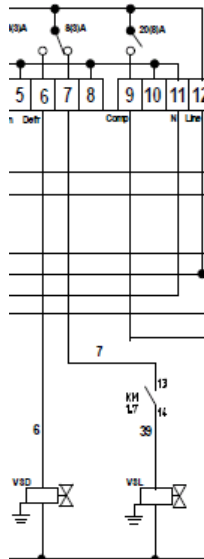

- Evaporator fan does not work. Analyze fan output on the microprocessor 4-0. In the display, under the fan symbol, the red dot must be fixed so that the fan output is activated, this will happen when pb2 reads 2°C below the FST value, that is, if the origin parameters have not been manipulated at 6°C in the low equipment and 8°C in the media equipment.
- Also check that the jumpers (0) of the terminal block make a good connection. Push bridges.

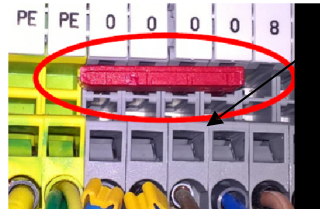
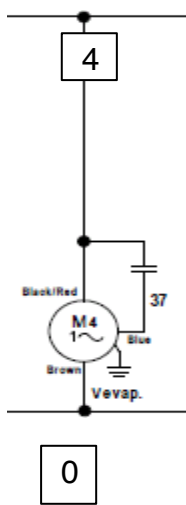

In the case that PA is open, indicative of stop by high pressure, causes:

- Error pressure switch or electrical connection pressure switch.
- Condenser input temperature too high, lack of air renewal or near heat source.
- Faulty condenser fan, fan start condenser or condensation control.

Feed directly from line (L) the cable that enters terminal 30, if the condensation control (Pcond) starts, it is defective, if it does not start fan or start capacitor is defective.

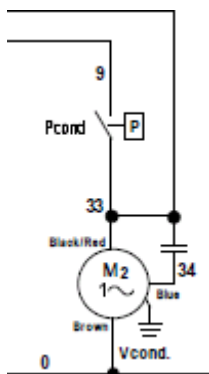

- Excess refrigerant or air in the circuit
- Dirty condenser.

States Network Protector

Single phase voltage protector ZHRV5-02

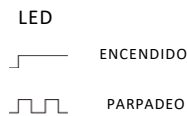
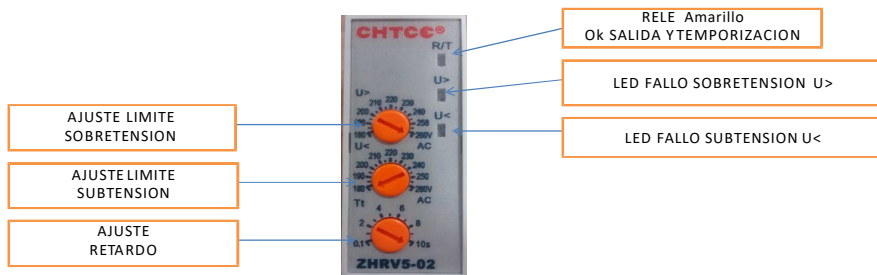

FUNCION	R/T LED AMARILLO	U> LED ROJO	U< LED ROJO
ERROR CONFIGURACION			
RELE SALIDA			
RETARDO DISPARO			
SOBRETENSION			
SUBTENSION			

Three-phase voltage protector ZHRV5-10

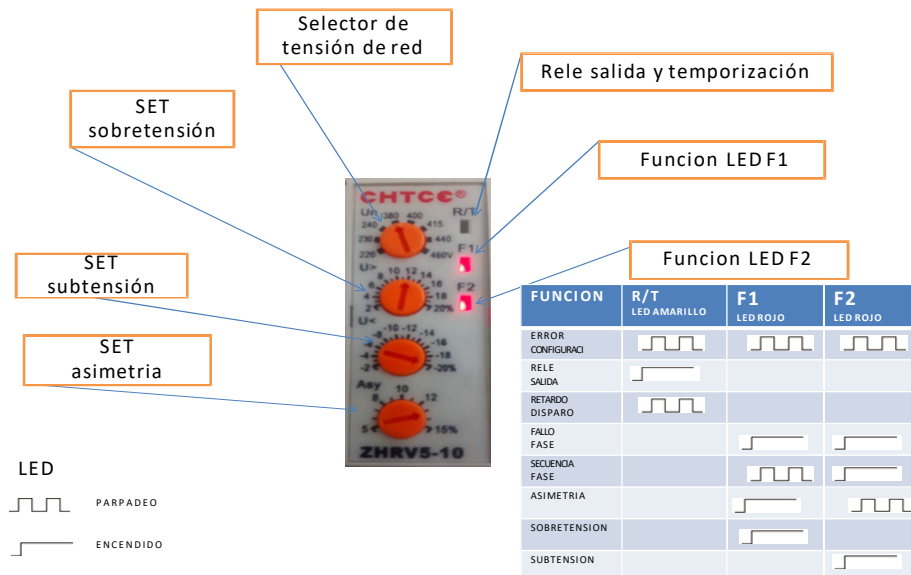

3.11. P1, P2, P3, P4 ALARM

Indicative of non-detection of the probe in the analog input of the microprocessor.

Possible causes:

1. Connection defective probe in the terminal or corresponding terminal according to alarm. Detect bad contact
Example: Alarm P1, check the connection as well as the contact of the cable tip that goes into terminals 16-17. If the alarm is maintained, exchange probe or defective analog input, change connection 17 to connection 15, if the P1 alarm disappears and the P2 alarm appears, it means deteriorated P1 probe, replace the P1 probe, return to the original connection, P1 terminal 17, P2 terminal 15.
2. If the exchange between connection 15 and 17 is made, the P1 alarm is maintained, the analog input is deteriorated, the microprocessor change.

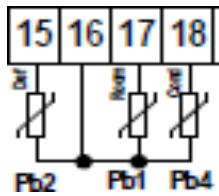

Rest of alarm probes; perform the same analysis to determine cause.

3.12. dA ALARM

Indicative of analogue input micro door open.

Possible causes:

- 1 Analogue input terminals 19-13, must be closed, check ferrules and connection, possible bad contact.
- 2 The micro door cable bridge has been cut. The cable for micro door supplied to be bridged, ie connected to each other.
- 3 Wrong micro door contact connection. If it has been connected to a switch micro door, it must be connected to a normally closed contact, with a closed door.

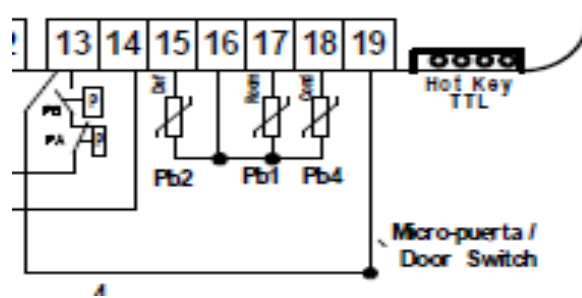

3.13. COMPRESSOR ALARM DOES NOT START

1 If the point under the cold symbol on the display is fixed, it indicates that the digital output of the board is active by program.

In this case check voltage at the output of the plate, coil A1 - A2 contactor KM for the activation of the compressor.

2 If the fixed point under the cold symbol on the display flashes, it indicates that the digital input of the safety series (High / Low pressure switch, voltage protector) is open, check causes 1-2 of point 3.10. Micro digital input door open, check terminals 19-13. Setting anti - short cycle time (parameter AC = 3 minutes).

Low symbol cold



A1-A2 compressor contactor KM

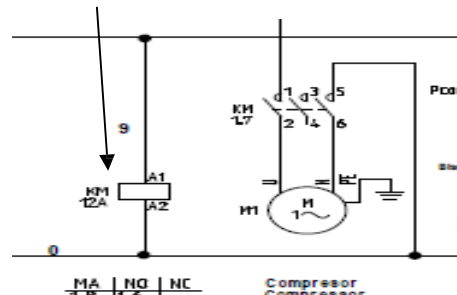

3.14. PARAMETER LIST

Code	Description	Cool.	Freez.
Set	Temperature setting	2 °C	-18 °C
Hy	Indicates the difference with respect to the temperature setting above which the compressor will start up	2	2
Ot	Thermostat probe calibration (1)	0	0
P2P	Probe 2 presence (the probe is connected)	Y	Y
Ac	Indicates the time of the anti-short cycle in minutes, the minimum time interval between the compressor stopping and starting up.	3 min	3 min
DISPLAY			
rES	Temperature precision, allowing a decimal figure if the value is "de"	de	de
DEFROST			
tdF	Indicates the defrost system installed (this parameter is not to be changed)	in	in
dtE	Indicates the temperature at which the defrost process ends	10 °C	10 °C
ldF	Indicates the time interval in hours between two consecutive defrosts	4	4
MdF	Indicates the maximum defrosting duration in minutes	25 min	25 min
FANS			
FnC	Indicates the fan operating mode	c-n	c-n
Fnd	Indicates the time in minutes that must elapse between the end of defrosting and the evaporator fans starting up	3 min	3 min
FSt	Indicates the temperature registered by the evaporator sensor at which the fans stop functioning	15 °C	15 °C
ALARMS			
ALU	Indicates the value for the abnormally high temperature alarm	10 °C	-5 °C
ALL	Indicates the value for the abnormally low temperature alarm	-5 °C	-35 °C
INPUTS			
i1P	Indicates the polarity of the digital input (pressure switches)	OP	OP
i1F	Digital input 1 operating mode	PAL	PAL
did	Indicates the time interval for calculating the digital input alarm (pressure switch errors)	20	20

3.15. EXTERNAL COMMUNICATION

If you install the optional "remote management", each unit must be connected via the connector TTL and a converter to a Modbus-RTU network compatible with the monitoring system XWEB

3.16. STARTING UP THE UNIT

Before starting up the cooling unit, the following operations must be performed:

- Plug the unit into the mains. The display will switch on and the word OFF will appear.
- If warm-up of the unit is required, it must remain in this state for at least three hours.
- If the unit has a voltage monitor incorporated, it must remain turned to OFF for at least 7 minutes, so that the monitor can run the calculation phase.
- Adjust the cold room temperature.
- Start up the unit by pressing the ON/OFF button.

CAUTION

**Average temperature adjustment field: +10/ -5°C
Low temperature adjustment field: -15/ -25°C**

Programming the cold room temperature:

- Plug the unit into the mains. The word OFF will appear on the display.
- To configure the desired work program, press the SET button and hold it down for three seconds. The green pilot light will come on and the set value will appear on the display.
- If you wish to change this value, press:

UP to increase it (never any higher than US).

DOWN to reduce it (never any lower than LS).

Press the SET button or wait for five seconds to view the cold room temperature again.

CAUTION

24 hours after start-up, check the evaporator conditions. If ice has formed on it, you will need to reduce the defrosting interval. For low temperature units, this inspection must be repeated once a week during the first month of use.

3.17. DIAGRAM OF THE UNIT ELECTRICAL SYSTEM

EUROMON units are characterised by a specific electrical installation, a diagram of which is enclosed with this user and maintenance manual.

4. MAINTENANCE AND CLEANING

4.1. MAINTENANCE AND REPAIR OF THE UNIT

Suitable maintenance is a determining factor for the unit to remain in optimum operating and performance conditions throughout a longer lifetime, and to guarantee the safety conditions established by the manufacturer.

All maintenance operations must be carried out by qualified and trained technicians.

4.2. ORDINARY MAINTENANCE

To always obtain a good functioning of the equipment, it is necessary to periodically:

- Verify weekly that the evaporator is clean, without accumulation of ice.
- Monthly (at least) perform a cleaning of the condenser (the periodicity of this cleaning depends mainly on

the environment where said unit has been installed). This operation must be carried out with the equipment stopped: it is advisable to use a jet of air from the outside to the inside. When this is not possible, use a long bristle brush from the outside of the condenser.

WARNING
To prevent risk of cuts to hands, use protective gloves.

WARNING
Switch off the electrical current before handling the unit.

CAUTION
Do not use solvents

4.3. PERIODIC AND PREVENTIVE MAINTENANCE

Check every four months:

- The state of wear of the electrical contacts and the contactors, cleaning them and, if necessary, replacing them.
- That the wiring and all terminals are properly tightened.
- Visually the entire refrigeration circuit to detect traces of oil or possible losses. Check the oil level.
- Make control of refrigerant gas leaks.
- Verify the correct operation of all the measuring, control and safety devices, as well as the protection and alarm systems to ensure that they are in perfect condition.

Every five years, check the entire refrigeration system or system (including safety valves and inspection of pressure equipment). Control the energetic performances of the installation.

4.4. SERVICING TO BE CARRIED OUT BY QUALIFIED STAFF

There follows a list of maintenance operations requiring specific technical skills and which must therefore be carried out by authorised, qualified staff.

The user must NOT carry out the following operations under any circumstances:

- replacement of electrical components
- manipulation of the electrical system
- repairs to mechanical parts
- manipulation of the refrigeration system
- manipulation of the control panel or the On, Stop or Emergency switches
- manipulation of the protective and safety device systems
- cleaning the condenser

4.5. TECHNICAL PROBLEMS

The following problems may occur during unit functioning:

1. Blocked compressor. There is a protective device which starts up whenever the maximum permitted temperature for the coils of the compressor's electric motor is exceeded.

This may happen if:

- The space the unit is located in is not sufficiently ventilated.
- There are anomalies in the electrical supply network.
- The condenser fan is not functioning properly.

This protective device goes back to its original position automatically.

2. Ice formation in the evaporator (preventing correct air flow).

This can be caused by:

- The door being opened too far, or being left open for too long.
- Incorrect functioning of the evaporator fan.
- Solenoid valve failure.
- Incorrect functioning of the defrost system.
- The unit being used for purposes other than those it was designed for, such as freezing products.

In such cases, certain operations can be carried out, always by qualified, authorised staff, unless the unit has been used for freezing:

- Increase the end of defrost thermostat temperature by a few degrees
- Increase the number of defrosts.

CAUTION

For defrost operations carried out as a result of ice blocking the evaporator, we advise against the use of metal tools, sharp or cutting tools, or hot water.

3. If the control unit display does not switch on, check:
 - That the unit is connected
 - That the supply cable connection is correct
 - The fuses on the electrical panel.
4. If the display switches on but the unit does not start up when the ON/OFF button is pressed, check the door micro switch connection is functioning correctly: remember that with the contact closed the door should be closed (if I1P=OP).

Poor performance of the unit:

In case of poor performance, after attempting to find the technical causes no anomaly is discovered in the system, check that the cold room doors are closing hermetically, that there is no cold dispersion in the cold room, that the staff is using the room with due care and that no unfrozen provisions or liquids have been stored in the room when it is used at a low temperature, and whether there is liquid in the evaporator.

It is also advisable to install the unit away from any doors, particularly if these are opened frequently each day.

WARNING

During functioning of the unit, it is strictly prohibited to remove the user protection devices fitted by the manufacturer.

4.6. FAILURE ANALYSIS

Symptom	Cause	Solution
Very high evaporator pressure with respect to air input.	<ul style="list-style-type: none"> a) Excess load b) High cold room temperature c) Compressor air intake not correctly sealed 	<ul style="list-style-type: none"> a) Collect refrigerant b) Check for overheating c) Check the state of the compressor and replace it
Very low condensation pressure	<ul style="list-style-type: none"> a) Insufficient gas b) Low cold room temperature c) Compressor air intake not hermetic d) Liquid circuit blocked e) Solenoid valve totally or partially open 	<ul style="list-style-type: none"> a) Locate leaks and complete the charge b) Wait for start-up c) Check the state of the compressor and replace it d) Check the dehydrator filter and the capillary tube or expansion valve e) Check the valve is not capped. Replace it if necessary
Very high condensation pressure (high pressure switch cuts out, "CA" alarm)	<ul style="list-style-type: none"> a) Insufficient flow or air recirculation b) Very high cold room temperature c) Condenser is dirty d) Excessive refrigerant charge (condenser flooded) e) Condenser fan has failed f) Air in cooling circuit 	<ul style="list-style-type: none"> a) Check air circuits (flow, recirculation, air outlet obstructed) b) Check temperature setting c) Clean it d) Collect refrigerant e) Repair it f) Drain and charge it
Evaporation pressure too low (low pressure switch cuts out, "CA" alarm)	<ul style="list-style-type: none"> a) Insufficient flow in evaporator. Air recirculation b) Evaporator frozen c) The liquid line is at a different temperature than the filter input and output d) Insufficient gas e) Very low condensation pressure f) Evaporator fan has failed 	<ul style="list-style-type: none"> a) Check the air or water circuits (flow, clean battery, etc.) b) Check the defrost system c) Change the filter d) Locate the leak, complete the charge e) Air temperature in the condenser is very low (very high air flow), adjust flow or relocate unit f) Repair it
Compressor will not start up, it does not sound (buzz)	<ul style="list-style-type: none"> a) Insufficient supply b) The contacts of one of the control elements are open c) Anti-short cycle timer preventing start-up d) Contact open e) Contactor coil burnt out f) Internal Klixon open 	<ul style="list-style-type: none"> a) Check differential switch and fuses b) Check safety chain on electronic regulation c) Check electronic regulation d) Replace it e) Replace it f) Wait for reset, check absorbed power
Compressor will not start up, motor sounding intermittently	<ul style="list-style-type: none"> a) Very low network voltage b) Supply cable disconnected 	<ul style="list-style-type: none"> a) Check line voltage and locate voltage drop b) Check the connections
Repeated stoppage and start-up of compressor	<ul style="list-style-type: none"> a) Due to high pressure b) Regulation differential too low c) Insufficient gas, cut-out due to low pressure d) Evaporator dirty or frosted up e) Evaporator fan not working, low pressure switch cutting out f) Capillary tube or expansion valve damaged or obstructed by impurities (low pressure switch cutting out) g) Dehydrating filter obstructed (low pressure switch cutting out) 	<ul style="list-style-type: none"> a) Check charge b) Increase short cycle difference c) Locate leak, recharge unit d) Clean it, check evaporator air circuit e) Repair or replace it f) Replace it, together with the filter g) Replace it
Compressor is making a strange noise	<ul style="list-style-type: none"> a) Fixing loose b) Insufficient oil c) Compressor defect 	<ul style="list-style-type: none"> a) Fix it b) Add oil up to recommended level c) Replace it
Noisy functioning	<ul style="list-style-type: none"> a) Unit installed without anti-vibration supports 	<ul style="list-style-type: none"> a) Install anti-vibration supports
Defrosting is not being performed	<ul style="list-style-type: none"> a) Electrical fault b) Defrost module not operative c) Solenoid has failed d) Regulation failure 	<ul style="list-style-type: none"> a) Locate and repair it b) Check parameters c) Replace it if necessary d) Locate and repair it

4.7. HOW TO ORDER SPARE PARTS

If you need to order any spares, please state the serial number figuring on the unit label.

WARNING

Components must only be replaced by authorised, qualified staff.

4.8. SCRAPPING THE UNIT

If the unit is to be scrapped, its components must not be abandoned in the environment; they must be disposed of through companies authorised to collect and recycle special waste, in accordance with the laws applicable in the country in which the unit is used.

WARNING

Cooling liquid must not be discharged into the atmosphere. It must be recovered and disposed of by companies authorised to collect special waste.

WARNING

Contains fluorinated greenhouse gases.

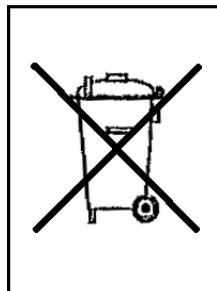

LENNOX EMEA se réserve le droit d'apporter toute modification sans préavis.
LENNOX EMEA reserves itself the right to make changes at any time without preliminary notice.
LENNOX EMEA Angaben und Abbildungen unverbindlich. Änderungen vorbehalten.
LENNOX EMEA se reserva el derecho de aportar cualquier modificación sin preaviso.